

# SECTION 5 / WOOD & VINYL SCREEN DOORS

PRODUCT	PAGE
Wood doors.....	74-75
Vinyl doors.....	75-76
Door list.....	76

## WOOD SCREEN DOOR ACCESSORIES

- 3920HDW-118 Bronze push button hardware kit for 1-1/16" wood door
- 3920HDW-WH-118 White push button hardware kit for 1-1/16" wood door

## Features

- 1-1/16" x 2-1/4" Frame
- Standard sizes only - No custom sizes  
30" x 80-1/2"  
32" x 80-1/2"  
36" x 80-1/2"
- Pinewood finger jointed frame
- Hardware sold separately

## Standard Finishes

- Natural – unfinished

**Sold in packs  
of four (4)**

Economy Wood Screen Door



## Features

- 1-1/16" x 2-1/4" Frame
- Standard sizes only - No custom sizes  
30" x 80-1/2"  
32" x 80-1/2"  
36" x 80-1/2"
- Pinewood finger jointed frame
- Hardware sold separately

## Standard Finishes

- Natural – unfinished

**Sold in packs  
of four (4)**

Economy Wood Screen Door



Economy Wood Screen Door

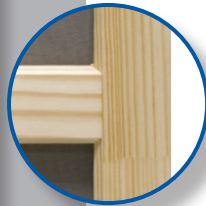

### Features

- 1-1/16" x 3-1/8" Frame
- Standard sizes only - No custom sizes  
32" x 80-1/2"  
36" x 80-1/2"
- Pinewood finger jointed frame
- Hardware sold separately

### Standard Finishes

- Natural – unfinished

**Sold in packs of four (4)**

Economy Vinyl Screen Door

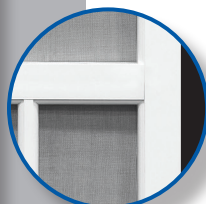
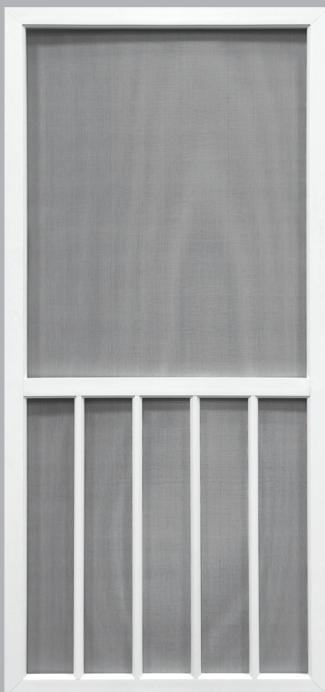

### Features

- 1-1/8" x 2" Low maintenance hollow vinyl frame
- Standard sizes only - No custom sizes  
32" x 80"  
36" x 80"
- Includes hardware pack (black)

### Standard Finishes

- White vinyl only

**Sold in packs of four (4)**

Precision screen door side and bottom adjustment channels allow for a standard size door to fit most applications. After measuring your opening, use this chart and determine if a standard door will fit.

Standard Door Width	Fits Openings From
36" Door - 35"	35-1/2" up to 36-5/8"
32" Door - 31"	31-1/2" up to 32-5/8"
30" Door - 29"	29-1/2" up to 30-5/8"
Standard Door Height	Fits Openings From
79-1/4"	80" up to 81"



## Features

- 1-1/8" x 2" Low maintenance hollow vinyl frame
- Standard size only - No custom sizes  
36" x 80"
- Includes hardware pack (black)

## Standard Finishes

- White vinyl only

**Sold in packs of four (4)**

Precision screen door side and bottom adjustment channels allow for a standard size door to fit most applications. After measuring your opening, use this chart and determine if a standard door will fit.	
Standard Door Width 36" Door - 35"	Fits Openings From 35-1/2" up to 36-5/8"
Standard Door Height 79-1/4"	Fits Openings From 80" up to 81"

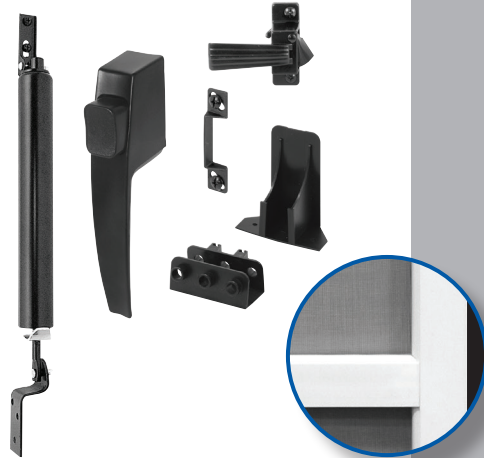

Economy Vinyl Screen Door

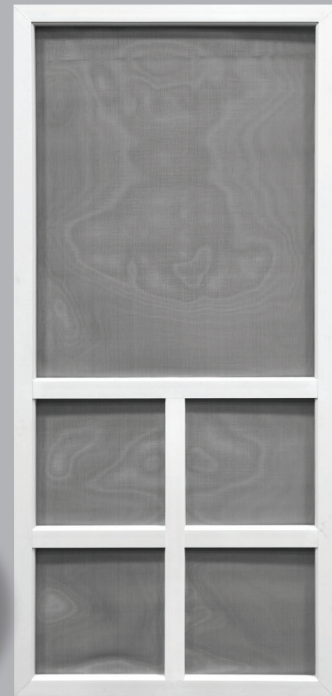

# WOOD & VINYL SCREEN DOORS Economy line

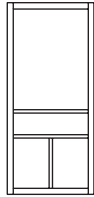
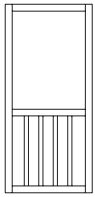
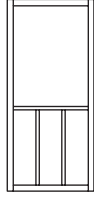
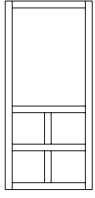
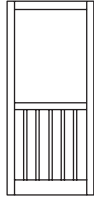
Name/ Series	Product Line	Description	Name/ Series	Product Line	Description
<b>Dogwood 3950</b> Page 74	<b>D3025</b>	 <p>1-1/16" x 2-1/4" Wood frame Available in 30", 32" &amp; 36" x 80-1/2" Hardware sold separately Natural – unfinished No custom sizes or finishes</p>	<b>Magnolia 3670N</b> Page 75	<b>D3610</b>	 <p>1-1/8" x 2" Hollow vinyl frame Available in 32" &amp; 36" x 80" Hardware pack included (black) White No custom sizes or finishes</p>
<b>Aspen 3951</b> Page 74	<b>D3025</b>	 <p>1-1/16" x 2-1/4" Wood frame Available in 30", 32" &amp; 36" x 80-1/2" Hardware sold separately Natural – unfinished No custom sizes or finishes</p>	<b>Vermont 3671N</b> Page 76	<b>D3610</b>	 <p>1-1/8" x 2" Hollow vinyl frame Available in 36" x 80" Hardware pack included (black) White No custom sizes or finishes</p>
<b>Nantucket 3952</b> Page 75	<b>D3025</b>	 <p>1-1/16" x 3-1/8" Wood frame Available in 32" &amp; 36" x 80-1/2" Hardware sold separately Natural – unfinished No custom sizes or finishes</p>			